

Mill Lining Solutions
Mill linings, mill trommels
and trunnion linings



Keep your
business
rolling





More than
50 years of
pioneering
developments

The world's most comprehensive mill lining supplier

Metso is a world leading mill lining supplier. The reason for this is simple; we offer our customers solutions that promote safety, improve grinding efficiency, and enhance profitability.

The mill is at the heart of your production process. The yield of your grinding operation is highly dependent on the performance of your mill's lining. Select your mill lining partner carefully. Who you trust to take care of the heart of your process is a matter of confidence.

Why choose Metso mill linings?

One supplier for your whole process



- Metso is the only supplier capable of supplying a full comminution offering including equipment, grinding media and mill linings of all types and materials

Service close to you



- Local sales and service offices in more than 50 countries
- Mill lining knowledge centers in your region are backed by global support
- Mill lining manufacturing in 14 factories globally

Leading edge technology



- Metso pioneered the use of rubber, Poly-Met, Megaliner and Orebed linings and has produced Metallic linings for over 30 years
- New products are constantly being developed to enhance our customers' ever more advancing processes

Unique expertise



- The world's largest resource of know-how - more than 50 years of mill lining experience
- Skilled design and service experts locally
- A team of world leading process technology experts

Higher mill availability



- Optimizing your lining's material and design leads to more efficient maintenance and higher mill availability
- With the market's most complete range of products, Metso can combine different materials in the same mill (Rubber, Poly-Met, Metallic etc) to tightly control the balance of liner life cycles

Lower total cost

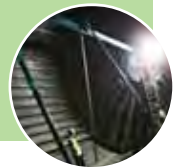

- Efficient and safe maintenance
- Continuous improvements to design and materials
- Cost-per-ton agreements - when you benefit, we benefit
- In-depth knowledge of every aspect of your process chain. This holistic approach is vital to achieving the lowest cost-per-ton

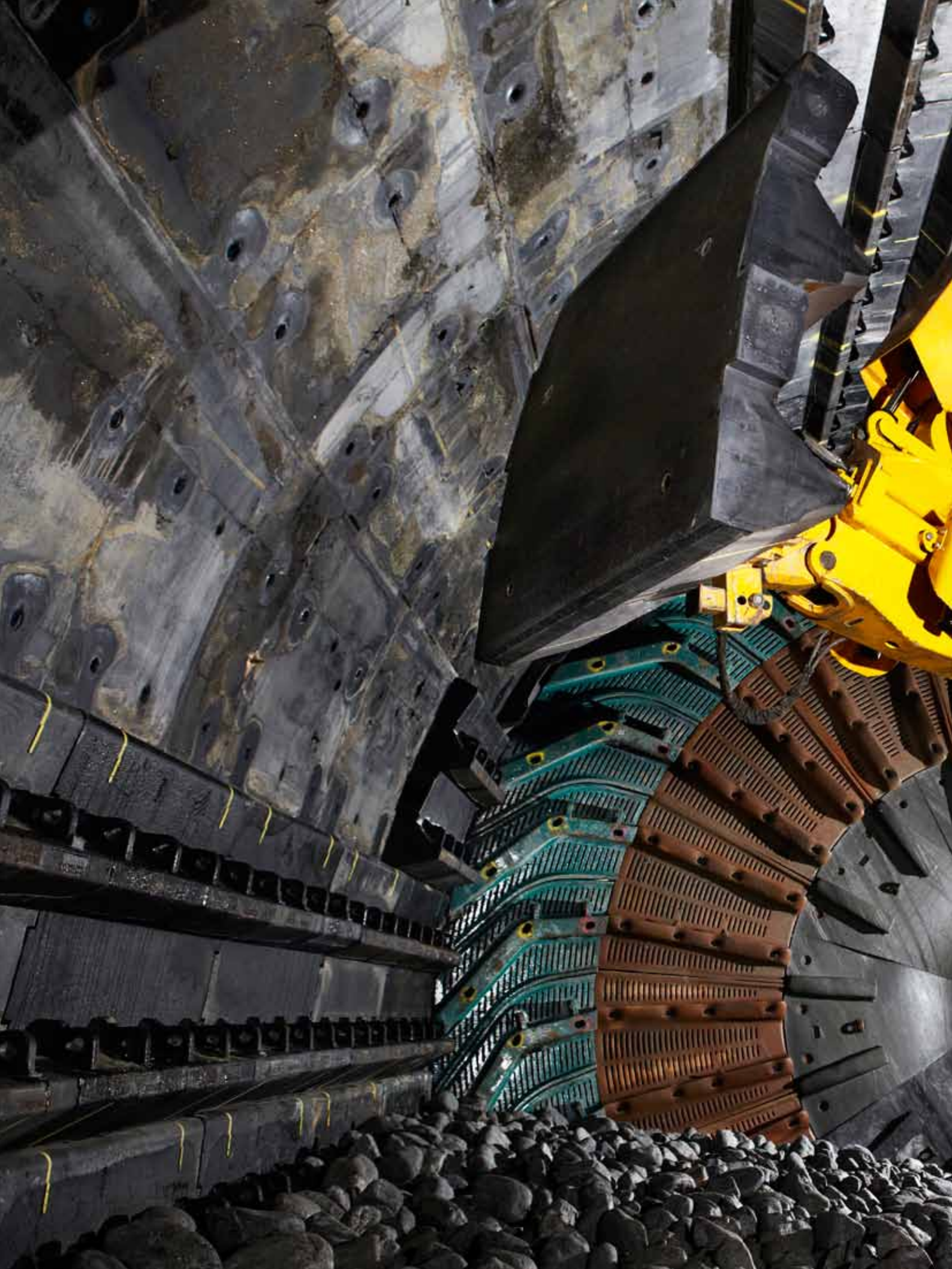



A mill lining is more than wear protection; it performs a vital function and has a great effect on grinding efficiency

With the largest product range to choose from, Metso offers mill linings with optimal materials and design for each specific application

The market's most complete product and service offering

Metso combines high quality mill linings with service, capital equipment expertise and process know-how, to offer our customers sustainable results, reduced operating costs, and lower maintenance expenses.

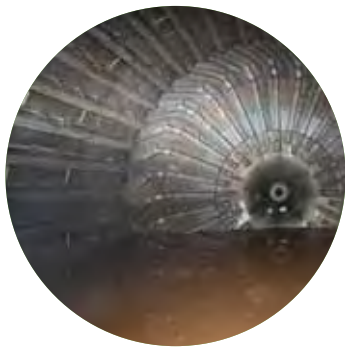

All types of linings*

No other mill lining supplier has as wide a product range as Metso. Different lining types can be combined in the same mill to achieve optimal performance.

- Rubber mill linings
- Poly-Met mill linings
- Metallic mill linings
- Orebed mill linings
- Megaliner™

See pages 10-15



All types of mills

Our state of the art linings are available for virtually all types of grinding mills.

- Fully autogenous mills
- Semi-autogenous mills
- Ball mills
- Rod mills
- Pebble mills
- Continuous mills
- Batch mills
- Vertimills
- Stirred media detritors



All parts in

- Head linings
- Shell linings
- Discharge systems
- Trunnion linings
- Mill trommel screens

* Typically found in mining applications, wet process

See pages 16-21

Health, safety and environment



- Safety is our top priority; we have developed the market's safest lining system and installation methods
- Our solutions help customers to improve their working environment, while making efficient use of energy

Process technology



Metso helps you improve profitability through overall process efficiency. We embed intelligence in our machines, services and processes.

- Audits
- Action plans
- SmartEar - measurement system for mills
- SmartTag - ore tracking system

Software

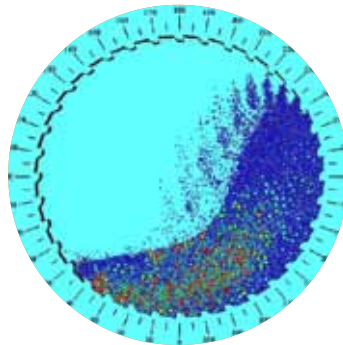

2D and 3D simulations and support software.

- Charge motion simulations
- Discharge systems simulations
- The market's most advanced software for comparing different lining alternatives and calculating total costs over lining life cycles

Services



Metso has the most extensive services hub network in the industry.

- Installation supervision
- Full 'turn-key' installations
- Life Cycle Services - Metso and customer share the same objectives
- Liner Positioning System - a unique system using cameras and a monitor to speed up mill liner installations and improve safety
- Several methods for wear monitoring, detailed analysis and reports with wear life predictions
- Lining design optimization

the mill





Identifying the appropriate type of lining and design is vital for optimizing mill throughput and total grinding costs, including costs for energy, grinding media and maintenance

The large mills of today process high tonnages, and every minute of production counts. The purchase price of an optimized lining accounts for only a fraction of the total grinding cost, but an inferior lining can prove to be very expensive



Our experience enables us to offer a solution that suits your needs and helps you streamline your production processes.

Rubber mill linings

In 1959, Metso, through Skega, was the first company in the world to develop and manufacture rubber mill linings.

Long experience with the development of rubber mill linings has led to an unparalleled bank of know-how. We offer you superior designs that ensure optimal grinding and lining performance.

Metso has developed grades of wear resistant rubber for specific operating conditions in all types of mills. Each grade is based on the experience of thousands of real-world applications.

Application areas

- Autogenous mills
- Semi-autogenous mills
- Pebble mills
- Ball mills
- FGD mills
- Rod mills
- Batch mills
- Continuous mills
- Scrubbers and washing drums
- Stirred media detritors

Main benefits

- Tailor-made design
- Safe and easy handling of light-weight components
- No leakage or peening
- Easy installation and replacement
- Reduced noise level - rubber acts as a vibration damper and noise filter
- We can simulate grinding and lining performance to evaluate selected applications and configurations
- Our approach to lining design is based on experience, grinding performance and improved mill availability

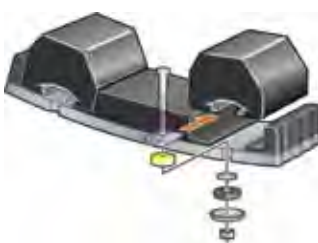

Standard attachment system

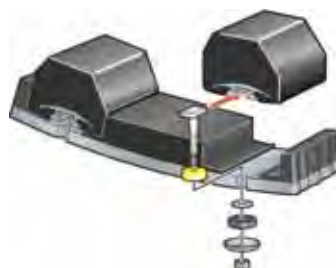

T-bolt attachment system



Mill linings from Metso are high quality products with long wear life.

Poly-Met mill linings

The development of the Poly-Met concept led to the first patent in 1987.

The Poly-Met concept combines the most desirable properties of rubber and steel to maximum advantage. This combination opens the possibility to use harder and more wear resistant alloys of iron and steel than can be used in conventional metallic linings, as the rubber substantially dampens impact forces.

In Poly-Met solutions where two materials are combined, extensive knowledge of materials and processes is essential to reach optimal grinding and lining performance. We know this product inside-out; we invented it.

Application areas

- Autogenous mills
- Semi-autogenous mills
- Ball mills
- FGD mills
- Rod mills
- Scrubbers and washing drums

Main benefits

- Alloys and profiles are tailor-made based on application and operating conditions
- Safe and easy handling of light-weight components
- No leakage or peening
- Long wear life
- Easy installation and replacement
- Designed to be installed using modern liner handlers
- Reduced noise level - rubber acts as a vibration damper and noise filter
- Improved mill availability
- The design is based on performance optimization using High Fidelity Simulation (HFS)
- Advanced Total Cost Comparison (TCC) software calculates total mill operating costs, including the value of lost revenue due to mill downtime



Equal height

Reduced downtime as a result of fewer stops for maintenance and monitoring of wear rates.



Wide spacing

Reduced change-out time as a result of fewer liner parts while reducing the probability of 'packing'.



High/low

Lining cost savings and performance benefits, since a profiled configuration is constantly maintained.



Low profiled

The perfect solution for fine, abrasive feed materials.



Metallic mill linings

Iron and steel are traditional mill lining materials, and Metso has produced metallic mill linings for more than three decades.

Metso metallic mill linings are produced at our own foundries. Our Cr-Mo steel and high-chromium white irons are specifically developed for mill lining applications and are carefully selected based on the operating conditions of each mill. Liners are designed for maximum performance and minimized replacement time.

The Metso foundries apply strict quality assurance programs in every phase of research, development, design and production. This ensures high, uniform quality for the entire supply. High quality standards also involve precise dimensions and close tolerances, so that every mill lining from Metso has a perfect fit.

Application areas

- Autogenous mills
- Semi-autogenous mills
- Ball mills
- Rod mills
- Vertimills



Our OEM parts for Metso Vertimills conform precisely to the complex geometry of the components they protect



We rigorously follow up on the performance of our designs, to ensure optimization of your production processes.

Main benefits

- Long experience with alloy and design selection for any mill application
- More than 30 years experience with the manufacture of metallic mill linings
- Fast installation, scheduled maintenance stoppages and long service intervals due to long life, high quality and optimized installation systems/methods
- Worldwide service network
- Tailor-made designs that are High Fidelity Simulated (HFS) for optimum performance and mill utilization

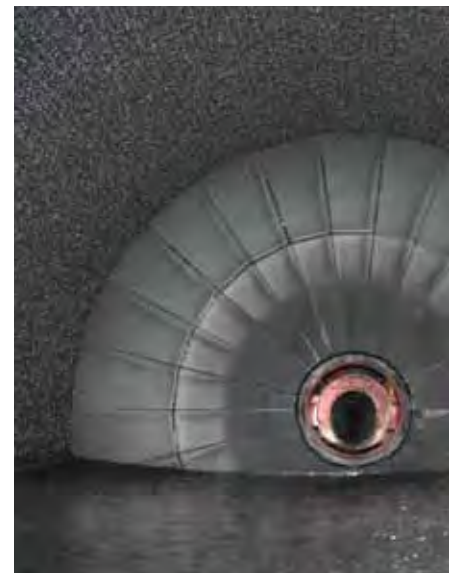
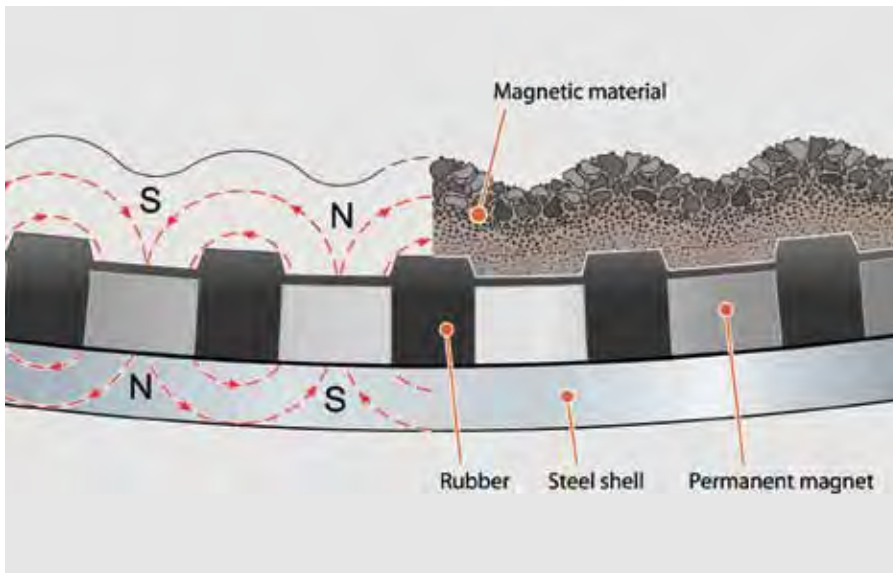

Metso develops tailor-made lining systems with focus on function, lifetime, and rapid installation.

Orebed mill linings

During the 1970's Metso developed and patented a magnetic lining system with unique properties, Skega Orebed®.

The Orebed® lining system consists of a series of powerful permanent magnets embedded within a matrix of highly abrasion-resistant rubber. Magnetic force ensures that the lining attracts the ferromagnetic material in the mill load, forming a continuous, self renewing wear layer with a wave profile. As a result, there is very little wear on the lining itself.

The configuration and installation of the entire lining is as simple as it could be. The embedded magnets hold the liner in place, so liner replacement is very easy.

Application areas

- Pebble mills (magnetic ore)
- Light duty ball mills
- Vertimills



The bodies of Metso Vertimills are lined with Orebed®.

Main benefits

- Almost 40 years experience with designing magnetic linings makes it possible for us to offer optimized solutions
- Rapid installation and no maintenance, since no bolts are needed and the attractive forces are so strong that it stays in place with constant performance for years
- The thin lining makes the grinding process more efficient and can increase throughput as a result of a greater mill working diameter



The innovative Megaliner™ concept is a product of Metso's unique, in-depth application experience, and understanding of customer objectives.

Megaliner™

In 2012, Metso launched the Megaliner™ concept, which substantially improves mill availability and worker safety.

Based on many years of experience and unique know-how, Metso has pioneered a new mill lining concept, the Megaliner™, which substantially improves mill availability and worker safety during mill liner maintenance activities.

As grinding mills are made increasingly larger, the cost of lost production due to downtime is becoming more and more important. In order to reduce downtime, liners are growing in both size and mass to minimize the number of components to be installed. Megaliner™ shell liner components are substantially larger than conventional metallic liners, yet are still light enough to be handled by the same 7- to 8-axis liner handlers.

The safest lining system of its kind

The innovative attachment system, patented by Metso, enables a quick and easy installation and removal of liners as well as a safer and less stressful environment for installation teams.

To make installations even safer and faster, Metso has also developed a camera based Liner Positioning System. Using this system, the liner handler operator can act alone to accurately position the liners without guidance from other workers.

Application areas

The Megaliner™ is suitable in large AG, SAG and ball mills with large trunnions and where modern liner handlers are available.

Features

- Each liner covers a large area, up to 5 m²
- Light-weight in relation to size
- Each Megaliner™ element integrates multiple lifter and shell plate rows
- Minimum number of attachment points
- Bolts inserted and removed from the outside of the mill
- Guiding markers facilitate easy positioning and alignment

Main benefits

- Mill availability is increased due to quick liner replacement. A minimized number of liners and attachment points per liner promotes significantly faster installation and change-out time, as compared to conventional liners
- Metso's unique attachment system makes it fast and easy to install and remove the liners. Old liners can be stripped out and new liners installed by the operator of the liner handler acting alone
- The attachment system also ensures that the liners are removed and replaced at a much higher level of safety. Liner bolts are inserted and removed from the outside of the mill and therefore there is no need for any member of the installation team to be in the danger-zone of the liners while inserting or removing liner bolts



Metso's patented Liner Positioning System uses camera technology to speed up mill lining installations even further and reduce the risk of accidents.



Megaliner™ for AG mills



Megaliner™ for SAG mills

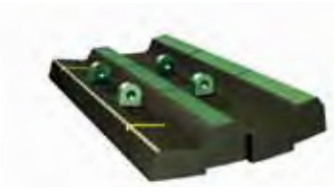

Megaliner™ for ball mills

Success case Boliden

Boliden's Aitik plant in northern Sweden was first to install the innovative Megaliner™ system in their new 38' x 45' AG mills.

Replacement of multiple Megaliner™ sets has proven to reduce shell liner change-out time by 30-40% as compared to conventional liners.

The customer greatly appreciates the comparative safety of the Megaliner™ system, since nobody needs to be in the danger-zone of the liners during installation or replacement.

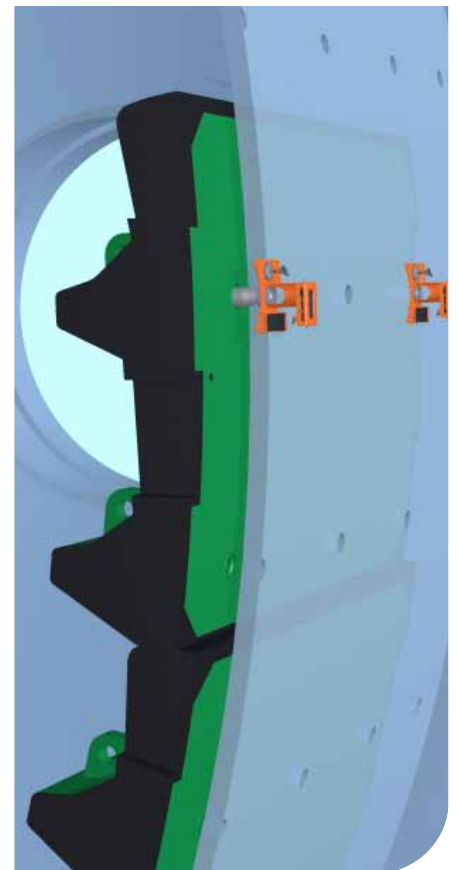

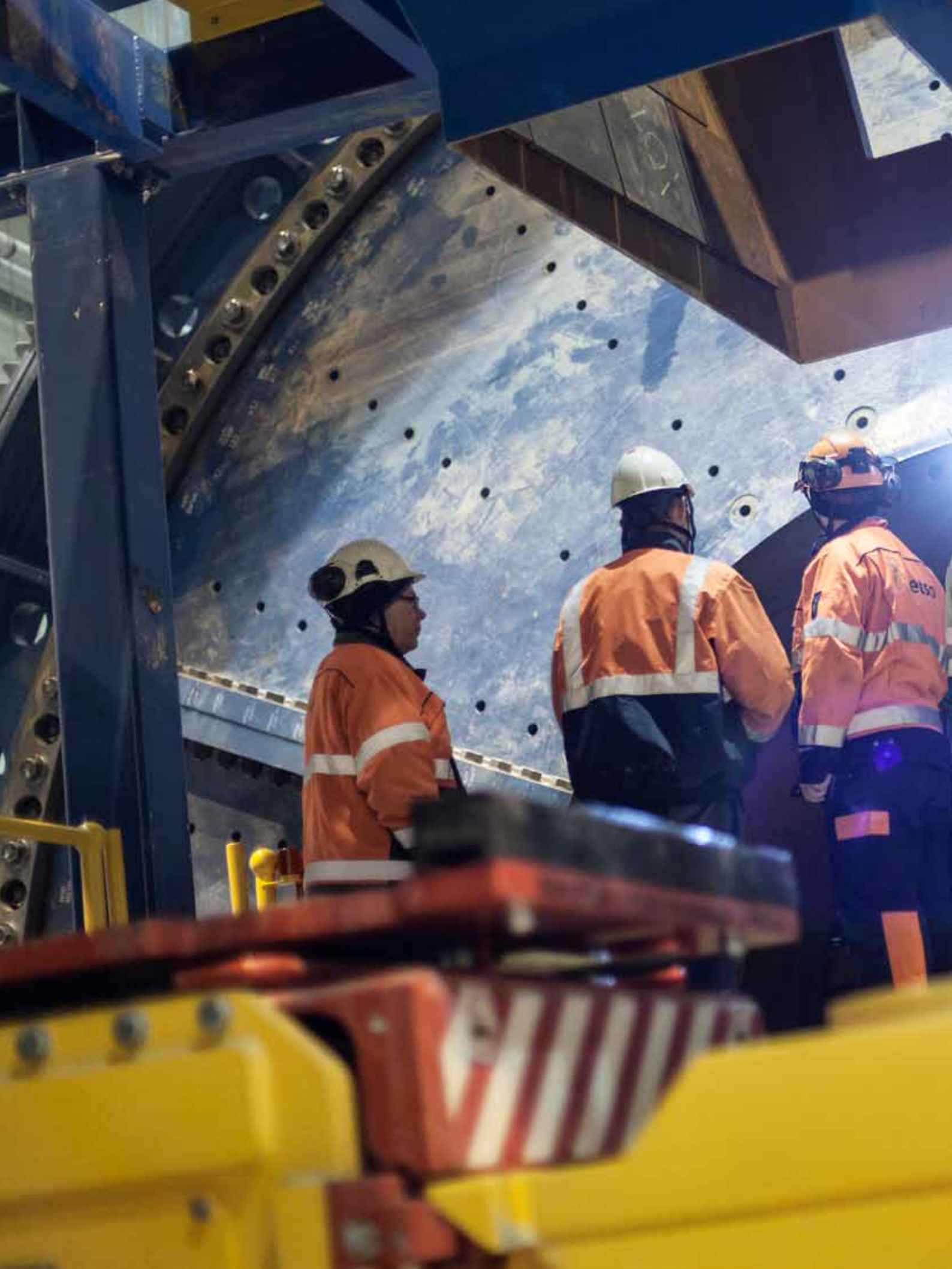

A worker in a high-visibility vest stands near a large industrial mill. The mill has a yellow lining and a metal surface with many circular holes. The scene is dimly lit, with a bright light source on the left.

From feed head through to the discharge system, Metso mill linings deliver benefits that add up to lower costs and more profitable operations

We work closely with our customers and carefully follow their process to make sure the linings we supply are always optimized for current operating conditions

Head linings

A balanced feed head lining design minimizes downtime.

As part of a system solution, the head lining is designed with consideration to the shell lining design. All components must be in balance to minimize the number of maintenance stops.

We try to keep the number of individual parts to a minimum, and to ensure that parts do not interfere with each other during installation. Liners that are most subject to wear are made more robustly, and whenever possible these high wear parts are designed to be independently replaceable.

Application areas

- Autogenous mills
- Semi-autogenous mills
- Ball mills
- Rod mills (metallic)
- Pebble mills
- Batch mills
- Continuous mills
- Scrubbers and washing drums

Main benefits - head linings

- Optimized design to minimize maintenance
- For smaller mills, light-weight design, for bigger mills, minimized number of parts to shorten installation time
- Wide selection of profiles
- Possibility to mix all different types of lining materials
- Tight fit and easy installation

Metso combines the best of all available liner types and materials, offering the ultimate mill lining solution!

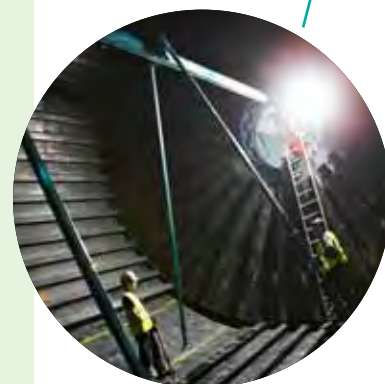
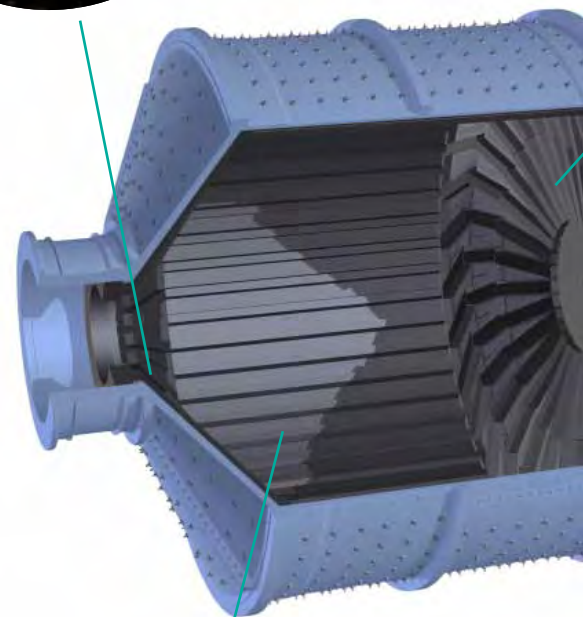

Metso has developed installation systems and working methods that generate considerable savings for our customers.

Shell linings

Metso shell linings - the key to efficient grinding.

The shell lining has a major influence on grinding efficiency. It transforms the mill rotation into charge motion and both profile and spacing must be carefully selected to suit each specific mill.

When designing a shell lining, Metso considers the type of grinding, mill size and speed, maintenance schedules, safety, impact levels, efficient use of materials, and many other parameters.

We use High Fidelity Simulation (HFS) tools to calculate charge motion, power draw and media to liner impact. Metso continues to follow up and adjust to changing operating conditions. Continuity is important.

Discharge systems

The design of your mill's discharge system has a substantial influence on mill performance.

Metso offers pulp lifters, discharge cones and diaphragm assemblies consisting of steel fabrications expertly lined with highly abrasion resistant rubber, optionally augmented with ceramic or metallic inserts. Our rubber grates are available in a wide range of aperture sizes, and their flexibility prevents blinding, ensuring that the entire open area is fully utilized.

For applications with high charge pressures and direct media impact, we also supply customized discharge systems manufactured of cast metal and metallic grates in a variety of wear resistant alloys.

When applicable, we can combine rubber and metal into a tailor-made system to save weight and utilize the unique properties of each material. We supply pulp lifters in radial, curved or 'dog-leg' configurations depending on the variables of mill size, speed and drilling patterns. All of our discharge systems are designed to maximize flow rate while minimizing back flow. This attention to detail also greatly simplifies installation, resulting in a minimum of downtime.

Application areas

- Autogenous mills
- Semi-autogenous mills
- Pebble mills
- Primary ball mills (light applications)
- Secondary/regrind ball mills
- Continuous mills

Main benefits - discharge systems

- Fits tightly to the mill's shape
- Long and predictable service life
- Easy and quick installation
- Custom-made design based on application and operating conditions
- Flexible rubber grates prevents blinding
- Ability to make light-weight rubber parts or heavy duty steel parts or combinations of both according to customer objectives



The experience and skill of our engineers ensures that our discharge systems conform perfectly to the contours of your mill, to prevent the harmful racing of slurry.

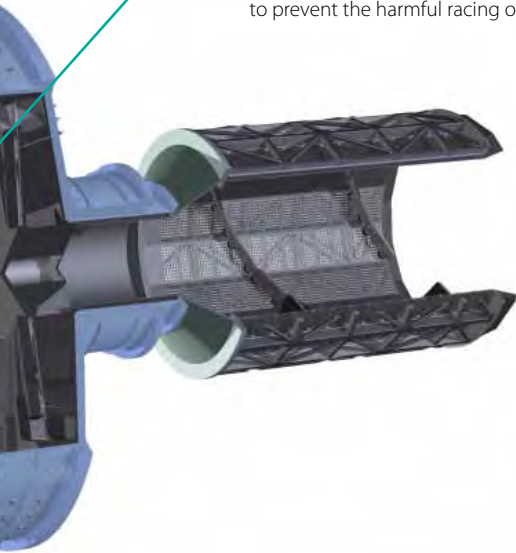

Application areas

- Autogenous mills
- Semi-autogenous mills
- Ball mills
- Rod mills
- Pebble mills
- Batch mills
- Continuous mills
- Vertimills
- Stirred media detritors
- Scrubbers and washing drums

Main benefits - shell linings

- Tailor-made design for each mill
- Each design is computer simulated for efficiency in the specific application
- Wide selection of profiles and lining materials
- Minimized number of liner details to shorten installation time
- Efficient material utilization
- Long wear life and balanced design to maximize mill availability

Trunnion linings

Trunnion linings - an important interface between the mill and surrounding equipment.

Metso trunnion liners are custom-made to protect your mill trunnions from internal wear. Fit is critical, and our trunnion liners can be made to almost any size or shape. Typical design features include internal spirals or dams to control material flow, flanges for the mounting of trommel screens, inclusion of threaded holes for jacking screws, inspection ports, etc. Metso trunnion liners are grouped into three categories.

One-Piece

This traditional alternative consists of a precisely machined external steel shell, lined with abrasion-resistant rubber. Trunnion liners of this type can often be refurbished for re-use. One-piece trunnion liners can also be supplied as cast metallic units.

Replaceable Sleeve

A light-weight, replaceable inner sleeve, is tack-welded into a heavier outer steel fabrication. It is possible to replace only the sleeve without having to remove the structural part. This design combines the benefits of simple installation with excellent lining economy, and is available for applications with internal diameters up to approximately 2.5 m.

Bolted Wear Elements

This system is suitable for the most extreme applications, for which the cost of downtime is of absolute importance. All parts exposed to wear are individually replaceable from the inside using a minimum of tools, and maintenance can be carried out without the requirement of removing the structural part of the trunnion liner.

Application areas

- All types of grinding mills, wet process

Main benefits - trunnion linings

- Light-weight components
- Easy to replace
- Designed to suit your specific mill
- Good liner economy
- Structural parts can be re-used
- Long wear life

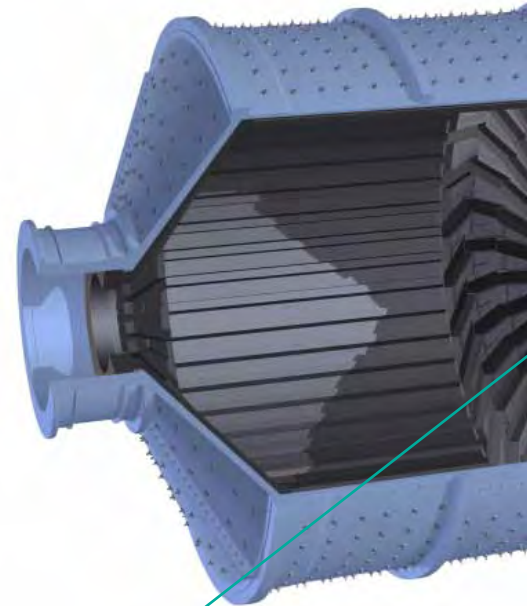

All Metso trunnion liners are manufactured to close tolerances to ensure precise, watertight installation.



Mill trommel screens

Mill trommels, whether used for sizing or scalping, play a vital role in your grinding circuit.

Metso's robust but light-weight trommel frames consist of carefully selected welded profiles that are covered in a protective layer of wear resistant rubber or polyurethane. Adapting flanges, if required are available to suit the design of virtually any trunnion or trunnion liner interface. There are two main types of screen panels.

Modular trommel panel

The modular type with snap-on attachment comes in a standard size of 305 x 610 mm. Installation and replacement of the snap-on screen panels is easily accomplished with a minimum number of basic tools, and since the panels are replaced from the inside of the trommel, there is generally no need to remove the trommel housing covers. This results in minimal if any impact on mill availability.

Customized trommel panel

The customized type can be used for small trommels and can be adapted to suit any size of frame.

For all types of screen panels, we select suitable apertures and open area for the specific application. Easily replaceable spirals and dams with different pitches and heights can be supplied for any type of trommel.

Application areas

- Autogenous mills
- Semi-autogenous mills
- Ball mills
- Pebble mills

Main benefits - trommel screens

- Frames designed to resist the effects of fatigue using FEA
- Light-weight panels are easily handled
- Quick and easy replacement
- Wide selection of apertures
- Tapered openings minimize or eliminate blinding
- The snap-on system offers flexibility; blind panels and panels with different aperture sizes or materials of construction can be combined within the same unit
- Available in rubber or polyurethane
- Panels in areas of elevated wear can be individually replaced

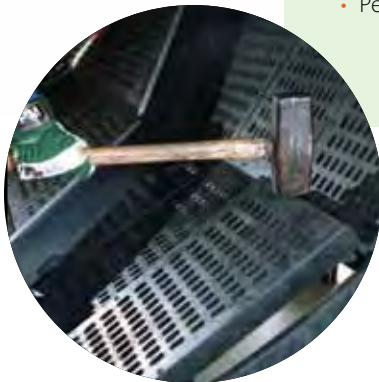
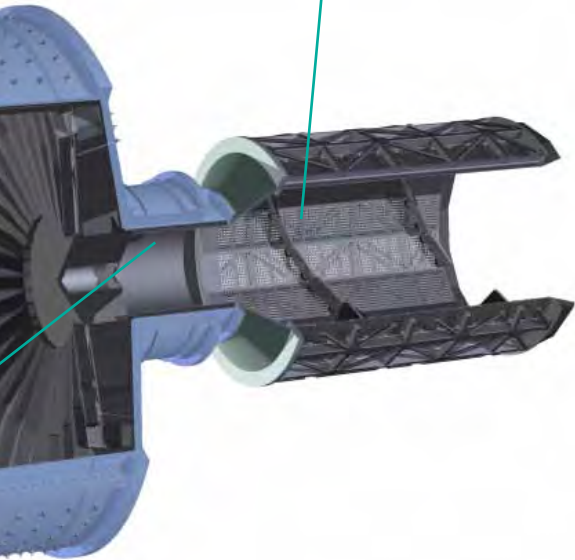



Metso mill linings clearly save time, trouble and money for companies in the mineral processing industry

This is supported by the fact that our linings are used in more than 4,000 mills worldwide

We serve the key players in the mining industry

Many of the world's leading mining companies trust Metso mill linings for a safer, more efficient process. In fact, customers in more than 100 countries select our linings.



Reliable supply is ensured through local production close to you

Contact us if you would like to find out more about how we can help you improve your profitability



Metso also offers mills and grinding media



Your mill linings are a vital part of your grinding operation, and can have a major impact on the performance of your circuit.

Metso is the market's most comprehensive supplier of mill linings and trommels. Please allow us to review your grinding process and identify areas of potential improvement. Together, we can produce a solution to make your production processes more efficient.

Our mill linings and trommels clearly save time and money, and improve productivity for companies in the mineral processing industry. This is supported by the fact that our linings are used in more than 4,000 mills worldwide.

Contact us if you would like to find out more about how we can help you increase your profitability.
www.metso.com/miningandconstruction

